

***TECHNICAL
INFORMATION***

CITIZEN QUARTZ

Cal. No. 891 ※ ※

 **CITIZEN**

§ 1. OUTLINE

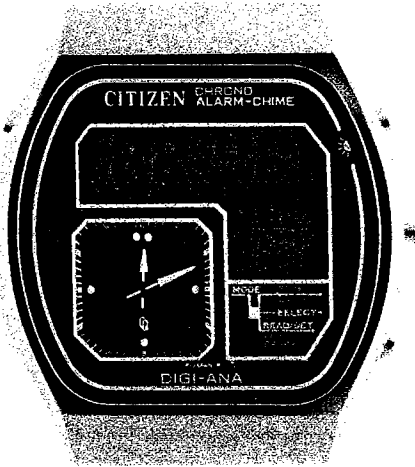

Compared with the same-group watch Cal. No. 8900 which is precedingly put on the market, this "digital-analog" watch features more multiple functions with addition of such mechanisms as the alarm, chime and the illumination lamp.

The merits and advantages of both the digital and analog mechanisms are "docked" together into a new-type wristwatch in good balance and harmony.

In terms of the design, the L-shaped LC display panel and the square dial are well matched to present an attractive external appearance as a whole.

§ 2. FEATURES

- 1) The electronic watch (with no center second) for gentlemen, featuring the quartz crystal oscillation and LC display.
- 2) Just one chip of C/MOS-LSI incorporates various circuits for oscillation, dividing counting, control, buzzer, boosting, driving of LC display panel and driving of step motor respectively.
- 3) Digital display of multiple functions
The diverse display functions include the time display (hour, minute and second), the calendar display (month, date and day), the chime, the alarm and the stopwatch.
- 4) 12-/24-hour digital display switching function
The switching is possible between the 12-hour and 24-hour digital displays, and at the same time an automatic switching is given conveniently for the alarm setting.
- 5) Automatic calendar setting device
An automatic calendar setting is possible including the leap years. Thus the calendar is set automatically after it is once set as long as the power cell life lasts. (1970 ~ 2009)
- 6) Power cell life indicator
When the voltage of the power cell drops down, the colon of the LC display panel flashes to indicate replacement of the power cell.
- 7) The "dual time" is available through simultaneous application of both the analog and digital watches.

§3. SPECIFICATIONS

Caliber No.	8910-08A/8911-08A
Type	Digital-Analog watch (with no center second)
Movement	Size: 30.0mm ϕ
	Thickness: 4.97mm
	Max. thickness: 5.98mm
Oscillation	32,768Hz
Accuracy	± 15 sec./month at normal temperatures
Digital display	FE twist-type nematic liquid crystal
	Hour, minute and second (Normal time display)
	Month, date and day (By switching)
	Chime (By switching)
	Alarm time (By switching)
	Stopwatch (By switching)
Analog display	Converter: Bipolar step motor
	Hour/minute hands: 4-second step movement
Integrated circuit	C/MOS-LSI (1 unit)
Effective temperature range	$\pm 0^{\circ}\text{C} \sim +60^{\circ}\text{C}$
Additional functions	12-/24-hour display switching function
	Illumination lamp
	Power cell life indicator
	Alarm monitor (Simultaneous push of both (L) and (R) buttons)
	Automatic calendar setting device
Power cell	Parts No.: 280-15 (WG-10)
	Nominal voltage: 1.55V (Ag ₂ O/K)
	Size: 11.6mm ϕ x 3.1mm
	Capacity: 75mAH
	Life: About 2 years

§ 4. HANDLING INSTRUCTIONS

1) Nomenclature

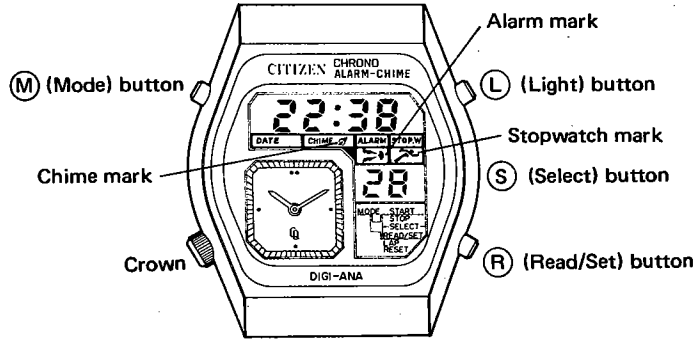

Time displayed above: 22:38'28" (24-hour display)

2) Mode switching

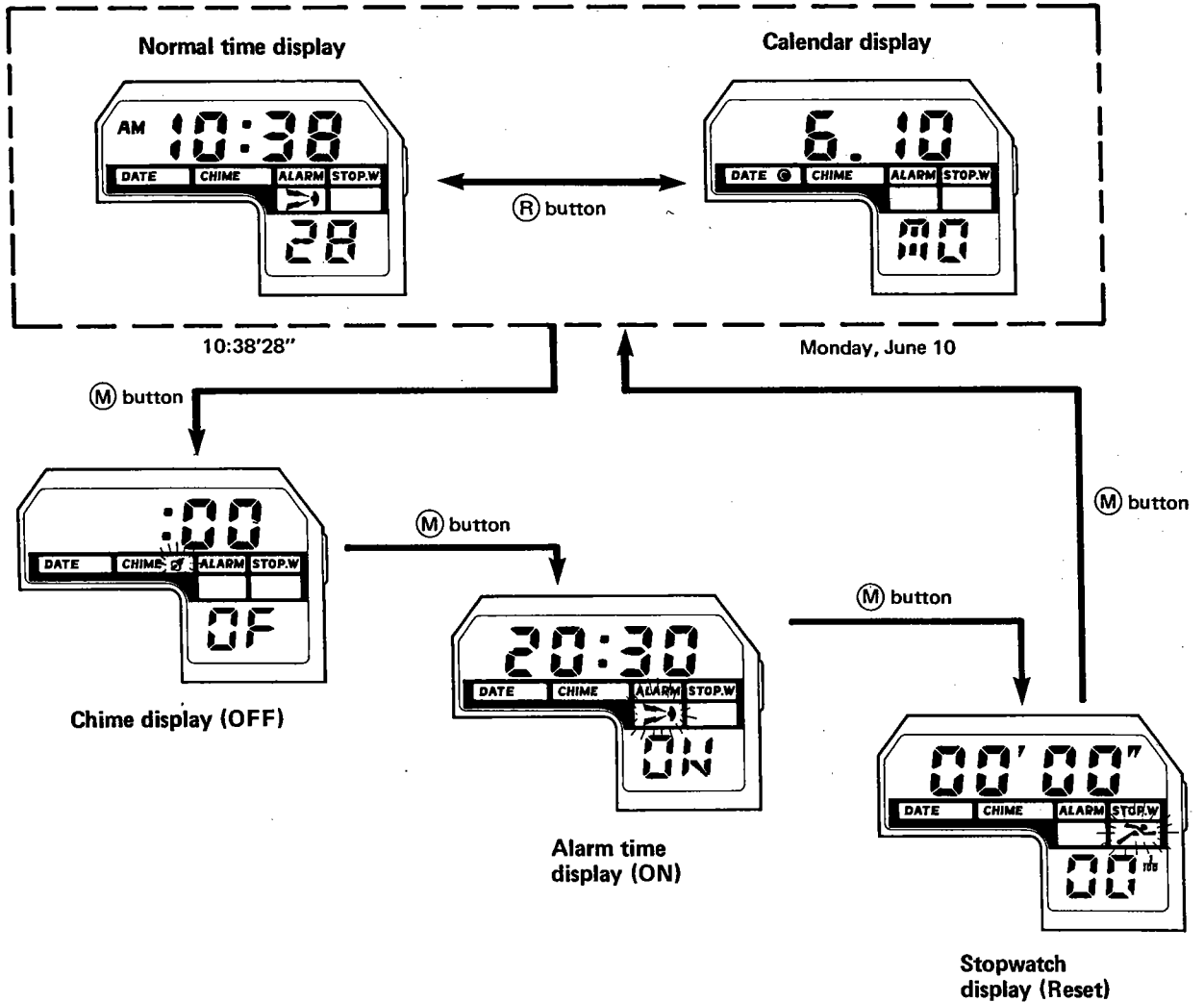

3) Setting of time and calendar (Digital)

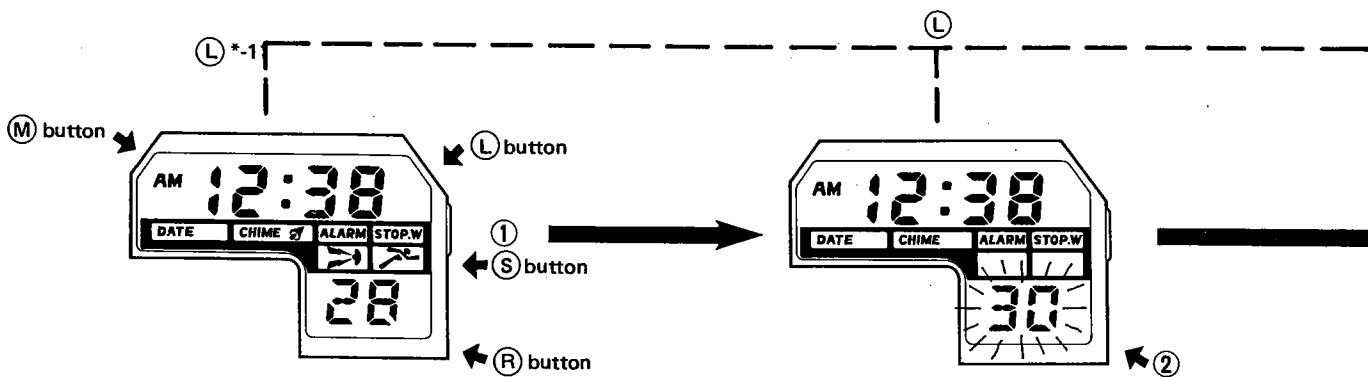

State of setting

① With push of (S) button about 2 seconds under the time display, the "second" flashes.

Setting of "second"

② With push of (R) button simultaneously with the standard time signal, "00" second is given. The "minute" is carried by one digit while the "second" reads 30 ~ 59.

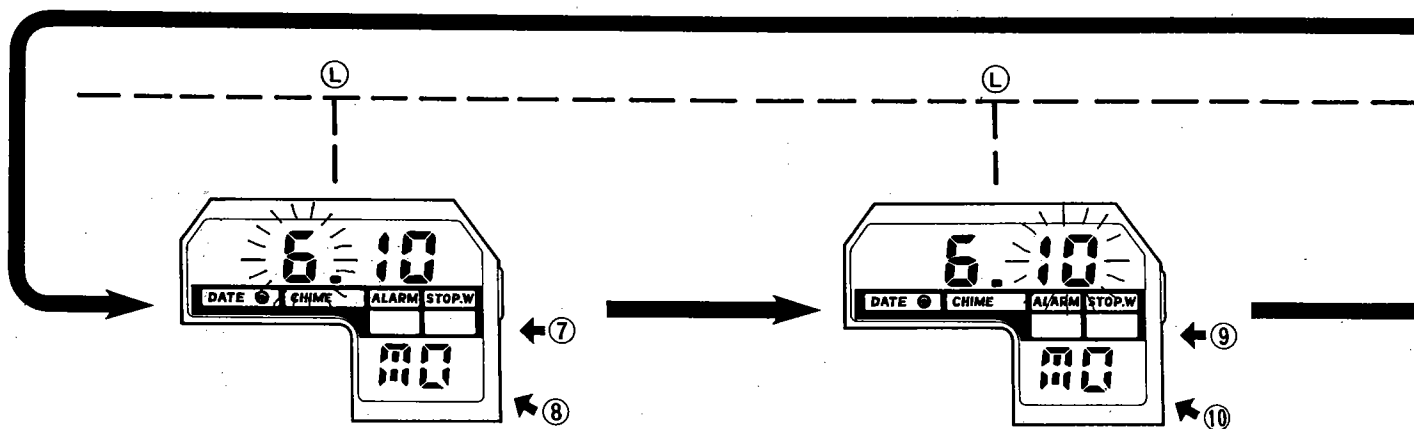

Setting of "month"

⑦ With push of (S) button, the "month" flashes.

⑧ The "month" advances with every push of (R) button.

Setting of "date"

⑨ With push of (S) button, the "date" flashes.

⑩ The "date" advances with every push of (R) button.

*-1: The time display can be reset from any setting mode with push of (L) button (Quick resetting device).

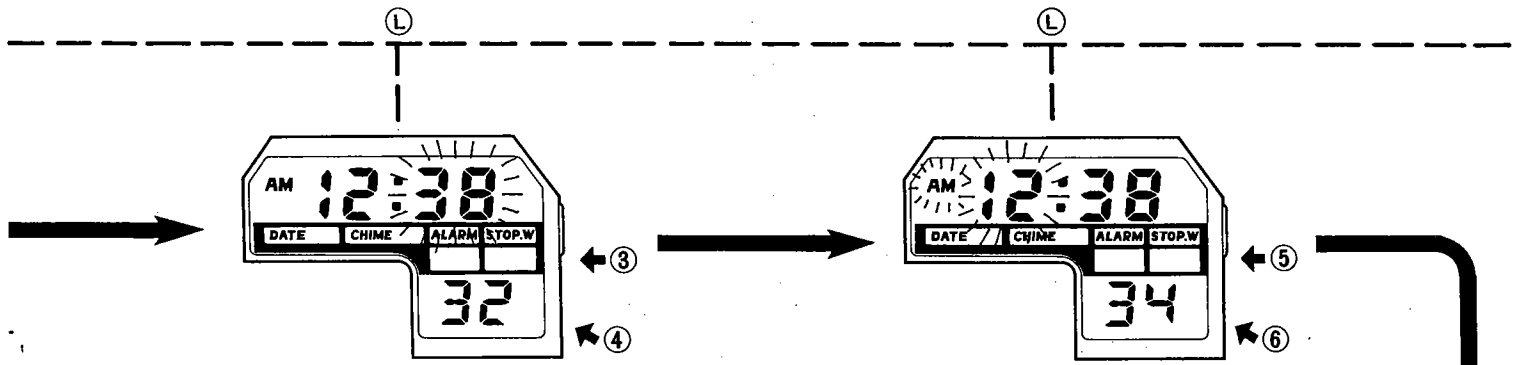

Setting of "minute"

- ③ With push of (S) button, the "minute" flashes.
- ④ The "minute" advances with every push of (R) button.

Setting of "hour"

- ⑤ With push of (S) button, both the "hour" and "AM/PM" flash.
- ⑥ The "hour" advances with every push of (R) button. Be careful of AM or PM.

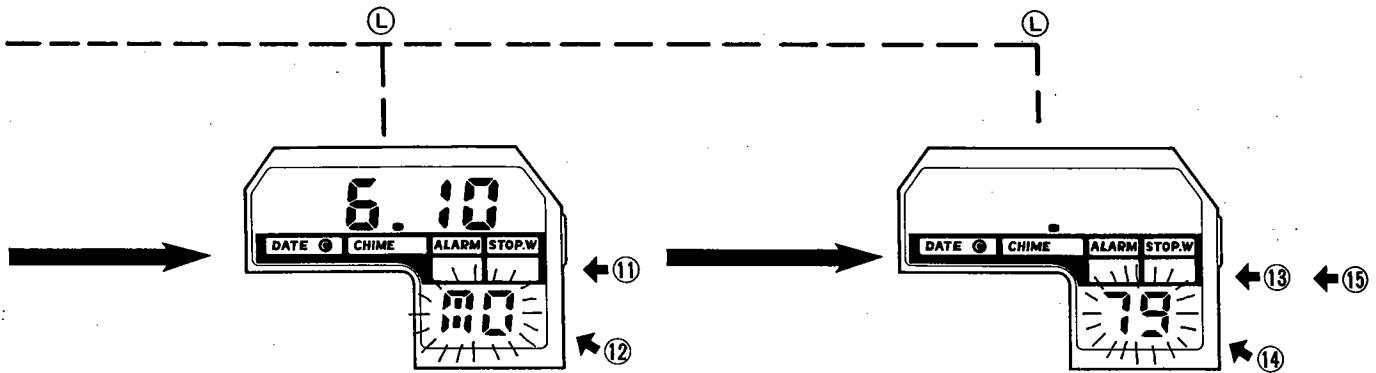

Setting of "day"

- ⑪ With push of (S) button, the "day" flashes.
- ⑫ The "day" changes with every push of (R) button.

Setting of "year" *-2

- ⑬ With push of (S) button, the "year" flashes.
- ⑭ The "year" changes with every push of (R) button.
- ⑮ With another push of (S) button the "time display" is reset.

• Abbreviations of "day" display

SU	: Sunday
MO	: Monday
TU	: Tuesday
WE	: Wednesday
TH	: Thursday
FR	: Friday
SA	: Saturday

*-2: The "year" can be set in the cycle of 1970 ~ 2009 years.

4) Setting of time (Analog)

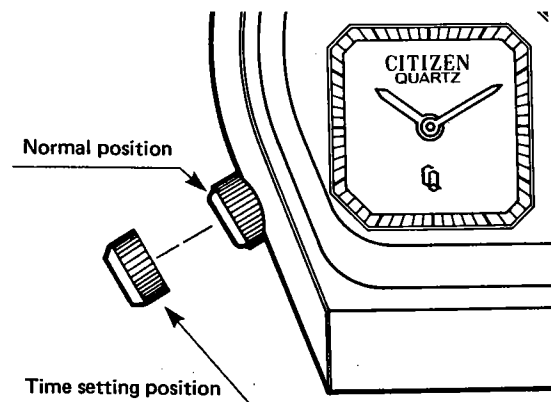

- (1) The crown is pulled out, and then the hands are turned to set the time.
- (2) When the time setting is over, the crown is pushed in completely.
 - The time can be set independently for both the digital and analog watches. Thus, the "dual time" (two independent watches) becomes available.
 - The hands move once every 4 second.
 - When both the digital and analog watches are set at one time, the digital setting must be done first.
 - The correction of ± 30 seconds is carried out through the digital watch. (As soon as the digital watch is set to 0-second, the minute hand is set quickly or kept holding when the second reads 30 ~ 59 and 0 ~ 29 each.)

5) Chime function

The chime display appears with push of \textcircled{M} button in the time or calendar display mode.

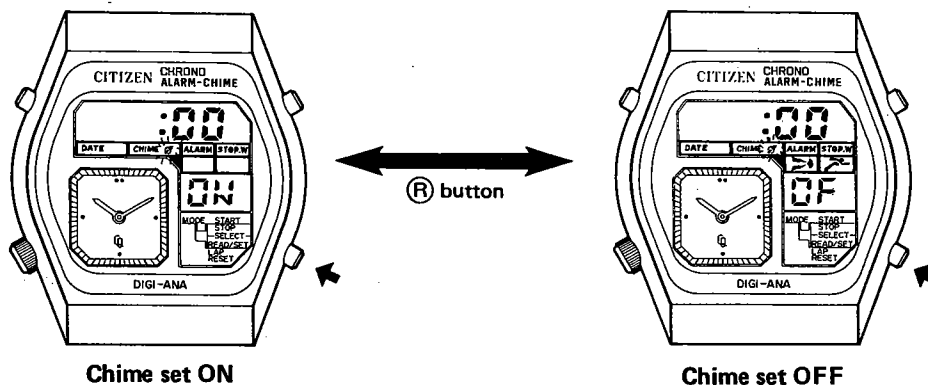

- (1) The ON and OFF of chime are switched alternately with every push of \textcircled{M} button.
- (2) When the time display is reset with the chime set ON, the $\text{「} \text{ } \text{」}$ mark appears to indicate that the chime is set.
- (3) With the chime set, the chime rings twice every hour on the hour (00'00'')

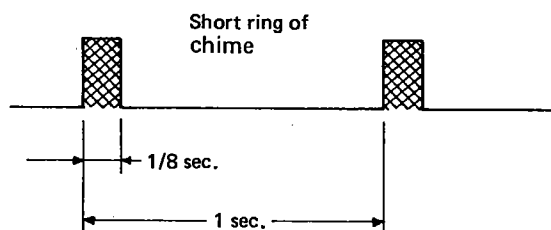

6) Alarm function

With push of (M) button in the chime display mode, the alarm display is given.

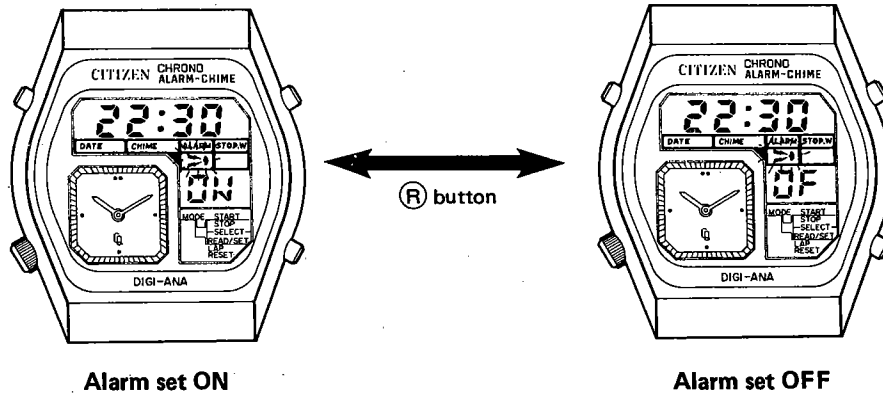

- (1) The ON and OFF of the alarm are switched alternately with every push of (R) button.
- (2) When the time display is reset with the alarm set ON, the "→" mark appears to indicate that the alarm is set.
- (3) With the alarm set, the alarm rings at the set time (hour and minute) in 8 times per second and for one minute in all.

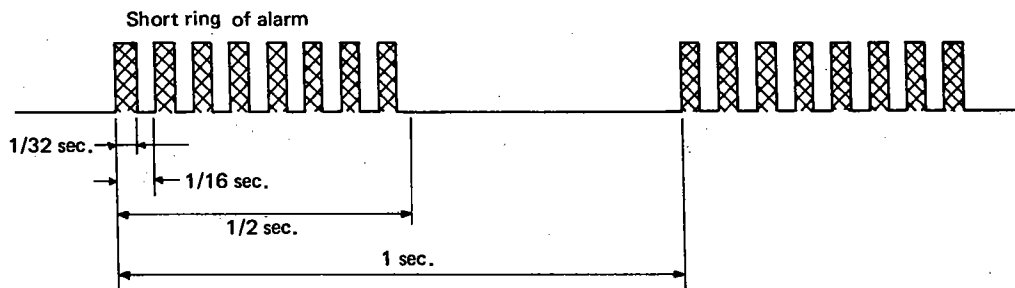

•Setting of alarm time

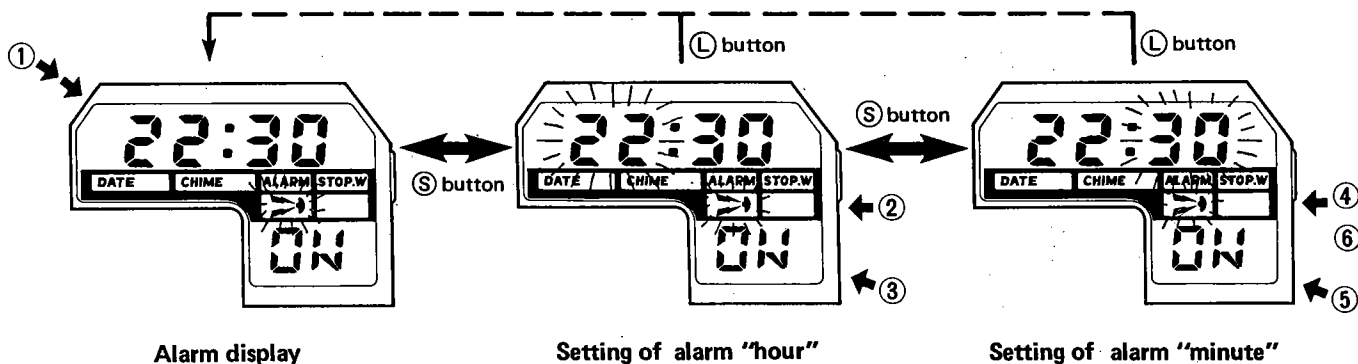

The AM/PM and the 12-hour – 24-hour switching are interlocked to the time display.

- ① The alarm time is called with push of (M) button twice in the time display mode.

- ② With continuous push of (S) button about 2 seconds, the "hour" flashes.

- ③ The "hour" changes with push of (R) button.

- ④ With push of (S) button, the "minute" flashes.

- ⑤ With push of (R) button, the "minute" changes.

- ⑥ With another push of (S) button "alarm time display" is re-set.

7) Stopwatch function

The stopwatch display is given by pushing (M) button in the alarm display mode. (The stopwatch function is identical to that of Cal. No. 8900A.)

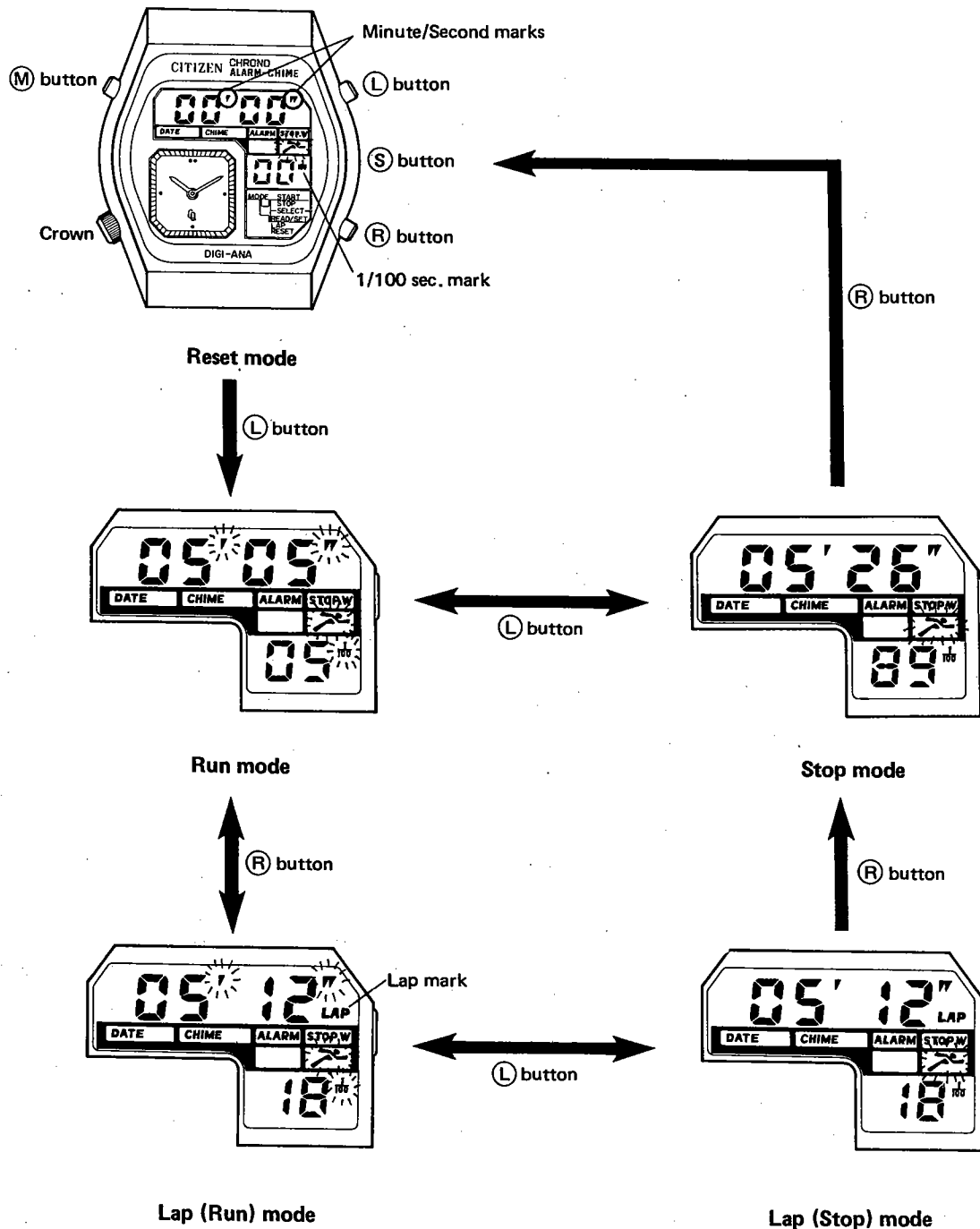

(1) Details of each mode

●Reset mode

The **00'00"00** is displayed to indicate the preparatory state for the stopwatch timing. With push of (L) button in this mode, the stopwatch function starts.

●Run state

The fact that the timing is being carried out is shown. With push of (L) button in this mode, the stop mode is secured and then the lap (run) mode secured with push of (R) button each.

●Stop mode

The stop mode is secured with push of (L) button in the run mode, and the timing is stopped. With push of (R) button in this mode, the **00'00"00** is displayed to secure the preparatory state again for timing.

●Lap (run) mode

With push of (R) button in the run mode, the lap (run) mode is secured. In this case, the display is kept but the timing is continued. With the second push of (R) button, the run mode is reset and then the lap (stop) mode with push of (L) button each. The "LAP" mark is displayed.

●Lap (stop) mode

With push (L) button in the lap (run) mode, both " " and 1/100 stop flashing and at the same time the timing is stopped with the same display maintained. This is the lap (stop) mode. With the second push of (R) button, the time elapsed up to the instant of the (L) button pushing. This is thus convenient for timing of both the 1st and 2nd winners.

(2) The  mark is displayed when the time display is reset under use of the stopwatch in the run or lap (run) mode, which indicates that the stopwatch function is under operation.

(3) The ring is heard to confirm the start and stop with every push of (L) button.

(4) When the timing exceeds **59'59"99**, the **00'00"00** is displayed with the timing continued as always.

8) 12-hour – 24-hour display switching and alarm monitor

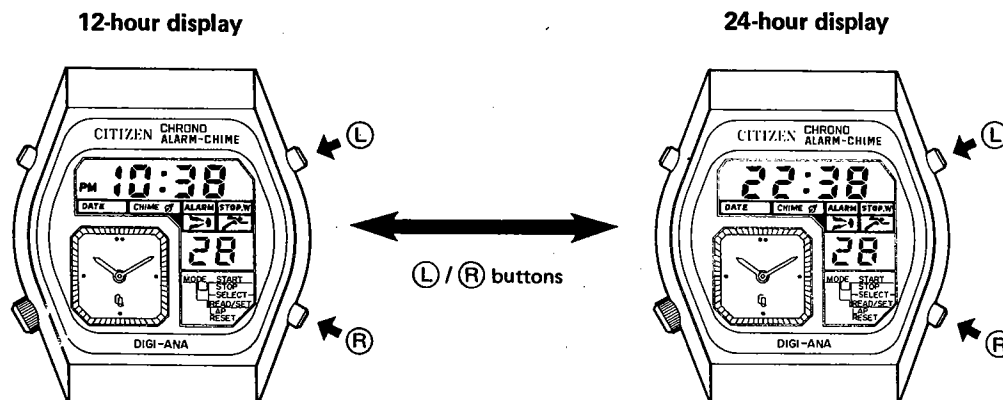

The switching is given between the 12-hour and 24-hour displays with the simultaneous push of both (L) and (R) buttons in the time display mode.

Also in this case, the alarm sound can be confirmed (Alarm monitor) with continuous push of (L) and (R) buttons at one time.

9) Power cell life indicator

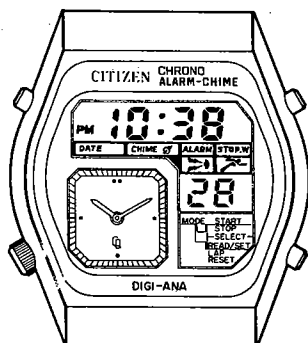

When the life of the power cell comes near its end, the colon (:) of the time display mode flashes. So the power cell must be replaced as soon as possible with new cell.

This colon flashing also occurs when the watch is put under the temperatures less than 0°C. In this case, the detection of the power cell voltage is indicated, and thus the flashing ceases when the watch is put again under the normal temperatures.

§5. STRUCTURE OF CIRCUIT

Both the analog and digital driving of this watch can be given by the 1-chip IC.

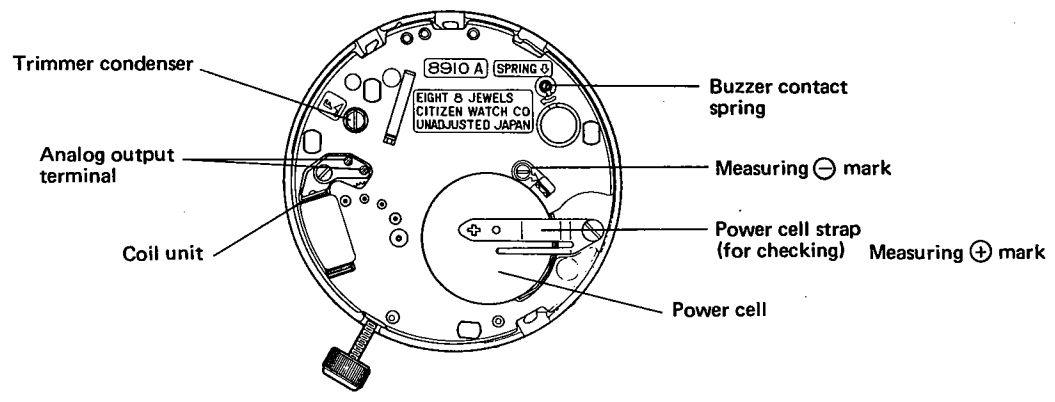
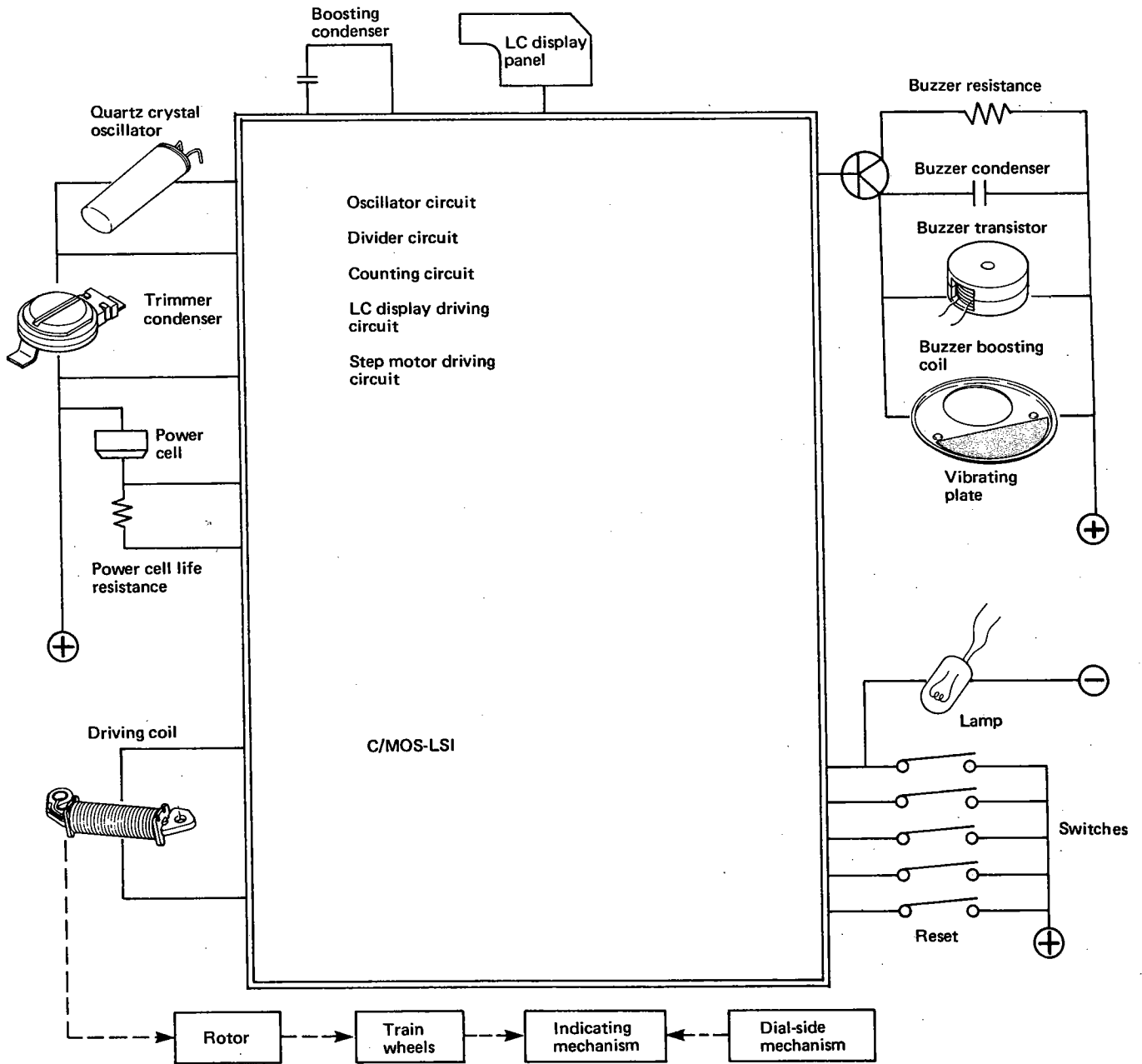

§ 6. HANDLING OF APPEARANCE PARTS

1) 8910A

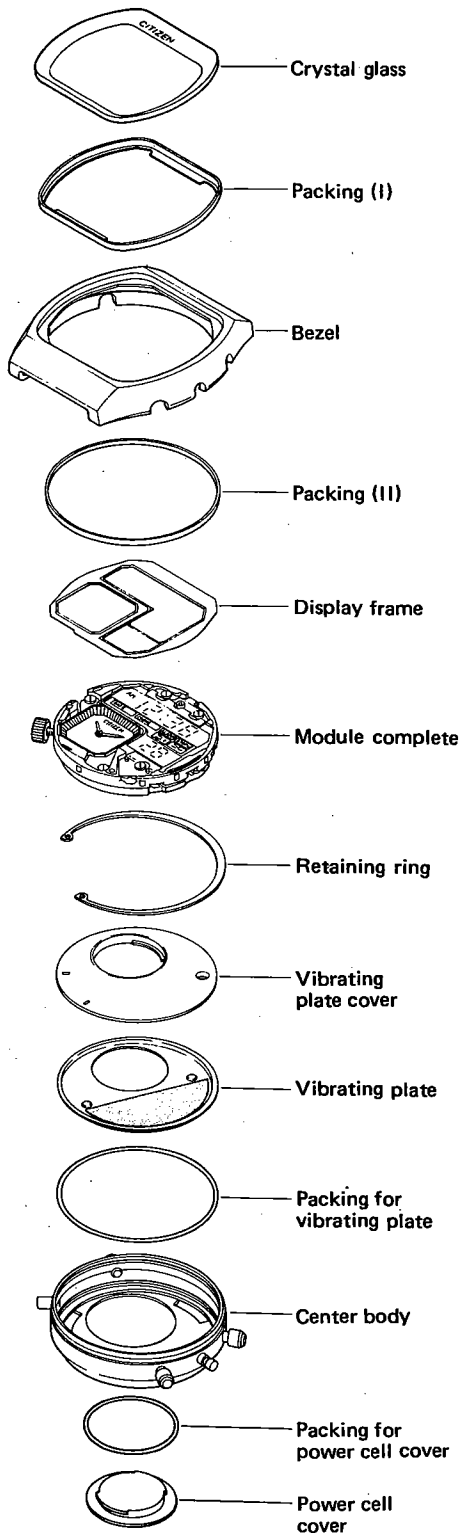
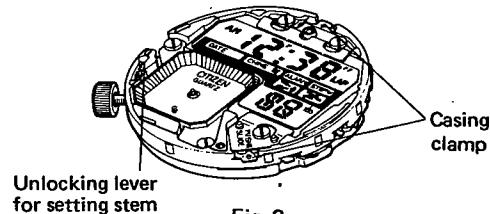

Fig. 1

As shown in Fig. 1, Cal. No. 8910A features the basic appearance structure of special-form GN4W. The watchcase contains the vibrating plate for alarm as well as the power cell cover. So a meticulous care must be paid for replacement of the vibrating plate.

① How to remove vibrating plate

- a. The power cell cover is removed.
- b. The bezel is detached from the center body using the pry-opener.
- c. The biting between the casing clamp and the center body is removed by pressing inward the casing clamp at two areas and then sliding it.



- d. The setting stem is removed by pressing the unlocking lever for setting stem, and thus the module can be taken out at the upper part.
- e. The snap ring of (M) button is removed to detach the push-button.
- f. The retaining ring is removed upward by pressing the two points inward with a tweezers. (Fig. 3)

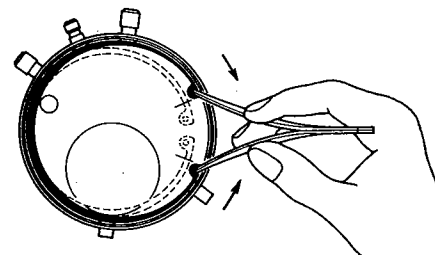

- g. The vibrating plate cover, the vibrating plate and the packing for vibrating plate are removed in that order.

*Make sure that the power cell cover is removed before detaching the retaining ring. If the retaining ring is detached first, the power cell cover cannot be removed.

② How to incorporate vibrating plate

- a. The packing for vibrating plate is set in.
- b. The vibrating plate and the vibrating plate cover are assembled together and then incorporated into the center body. The vibrating plate is set with the piezoelectric element side up, and the vibrating plate cover is set with the retaining ring set position mark turned up respectively. (Fig. 4)
- c. The assembly of the vibrating plate and the vibrating plate cover is picked up with a tweezers and then inserted under the push-button. (Fig. 5)
- d. The retaining ring is set in with the unfinished surface part set down.
- e. Both point A and B must be matched with point a and b of the retaining ring set position marks respectively. (Fig. 6)
If the above matching has some shift between those matching points, the disconnection may be given to the coil unit of the analog watch.
- f. The (M) button is set in after making sure that the retaining ring has been incorporated completely.
- g. Thus, the vibrating plate has been incorporated into the center body. After this, the module is put into the center body in a usual way and then into the bezel.

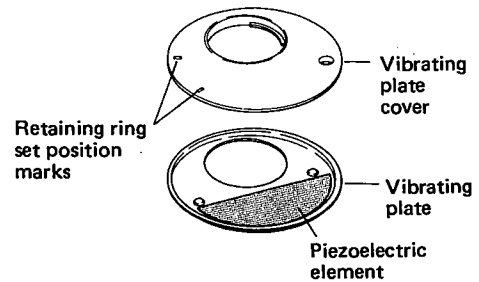

Fig. 4

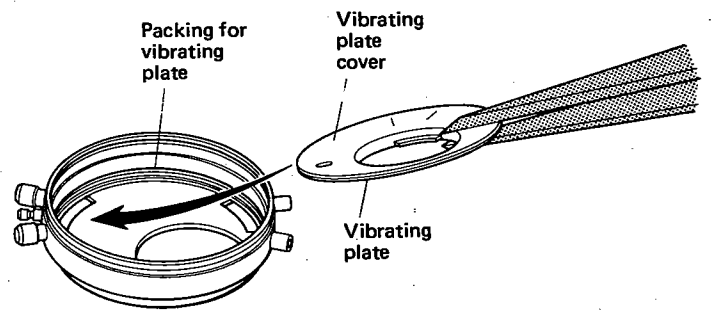

Fig. 5

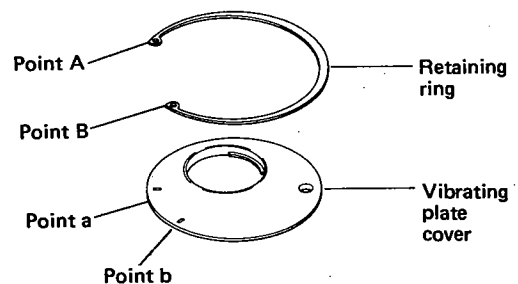

Fig. 6

2) 8911A

The Cal. No. 8911A features the basic appearance structure of special-form GN4W (upper-opening), and the caseback features the snap-type since the power cell cover is not attached. (Fig. 7)

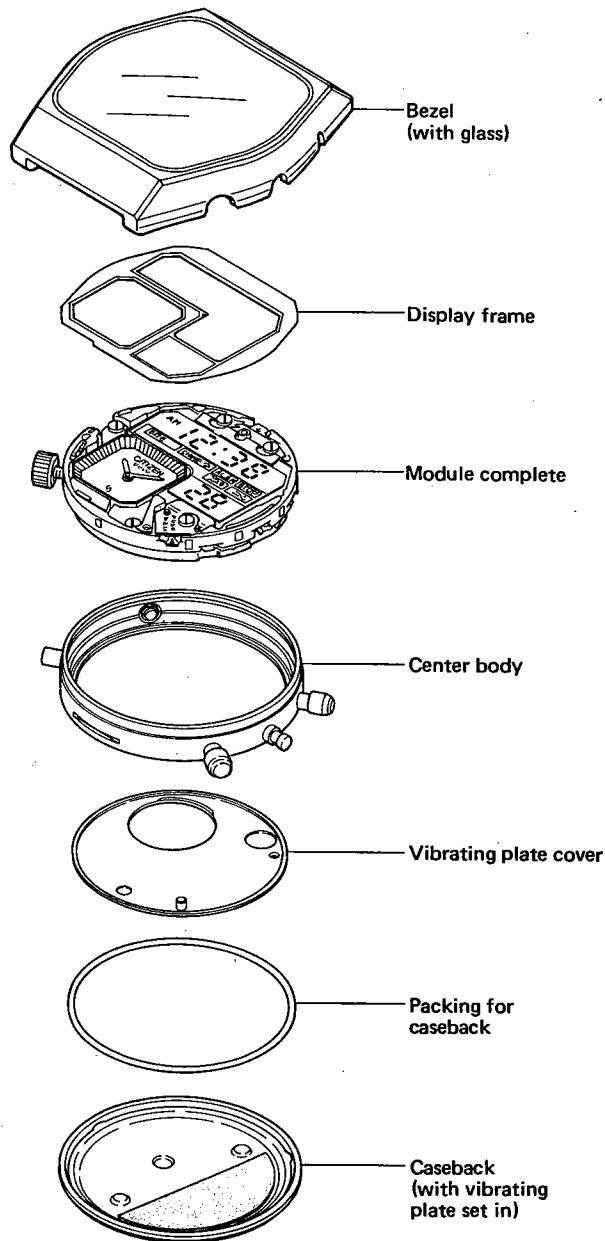

Fig. 7

① How to incorporate vibrating plate

- a. The module is set into the center body from the upper side and then put opposite after setting the display frame and the bezel.
- b. As illustrated in Fig. 8, the vibrating plate cover is set in with the lower projection to be put into the hole of the device cover and centering on both the power cell and the buzzer contact spring.

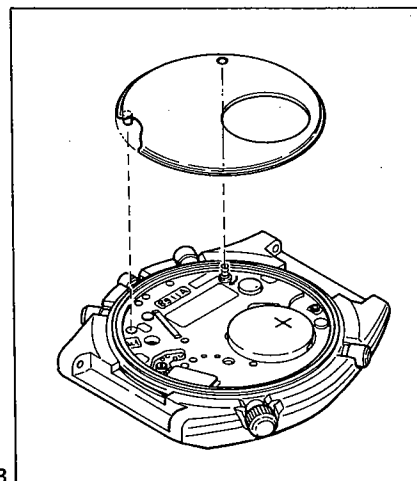

Fig. 8

- c. A proper gap must be secured between the buzzer contact spring and the hole of the vibrating plate cover.
- d. The packing for vibrating plate is put onto the projection of the back of the power cell and at the caseback side of the vibrating plate. (Figs. 9 and 10)

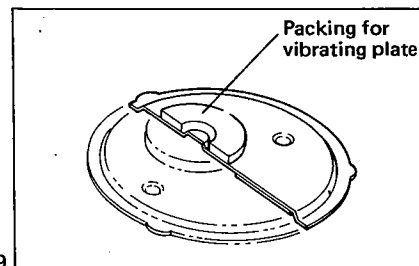

Fig. 9

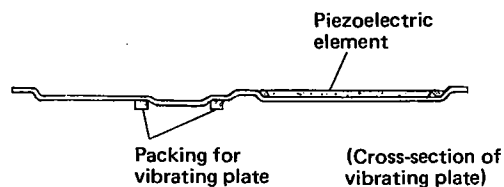

Fig. 10

- e. The vibrating plate and the caseback are assembled together. In this case, the outer circumference projection at the area (opposite to the piezoelectric element part) where the power cell of the vibrating plate is put in must be set in the same direction as the pry-opening slit of the caseback. (Fig. 11)

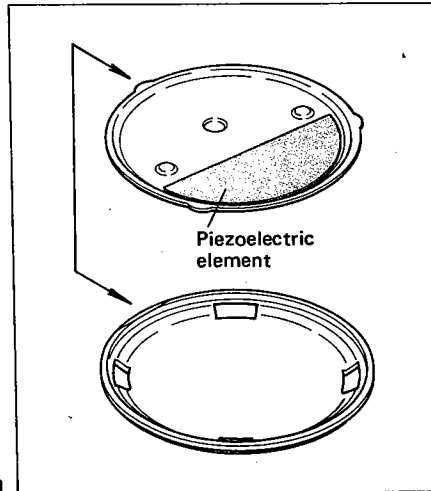

Fig. 11

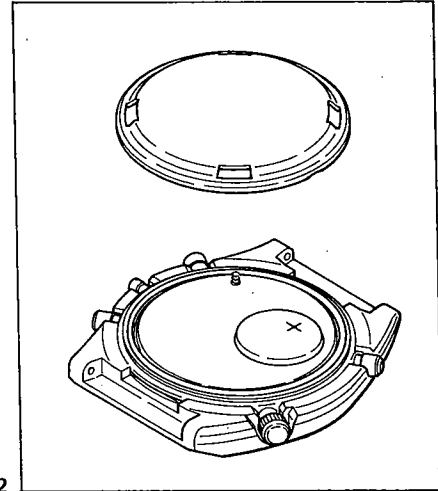

Fig. 12

- f. The caseback (with vibrating plate set in) is set into the center body. In this case, the slit of the caseback must be turned toward the 9-o'clock direction of the center body.

§ 7. DISASSEMBLY/ASSEMBLY AND LUBRICATION

1) Power cell side

Disassembling procedure: ① ~ ④④
 Assembling procedure: ④④ ~ ①

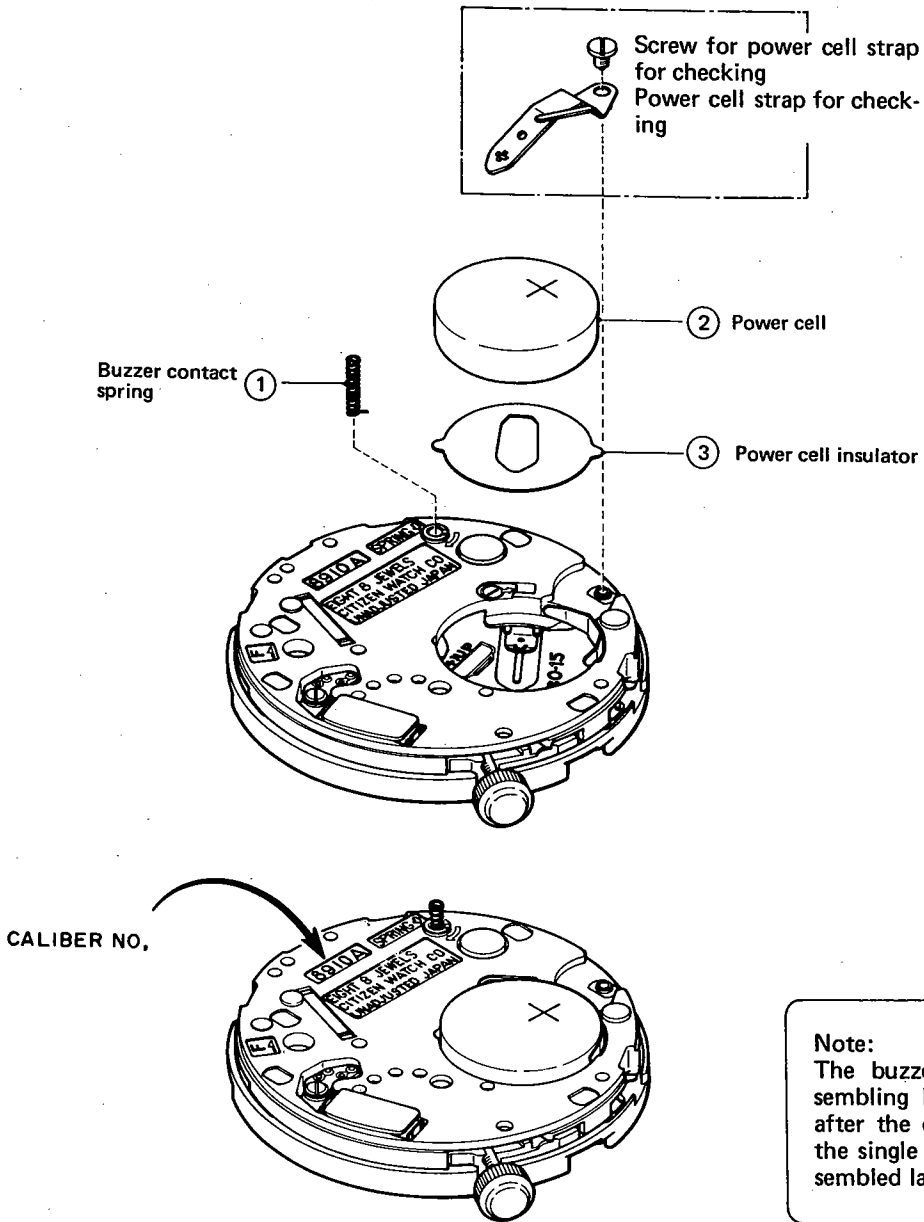

2) LC display panel side

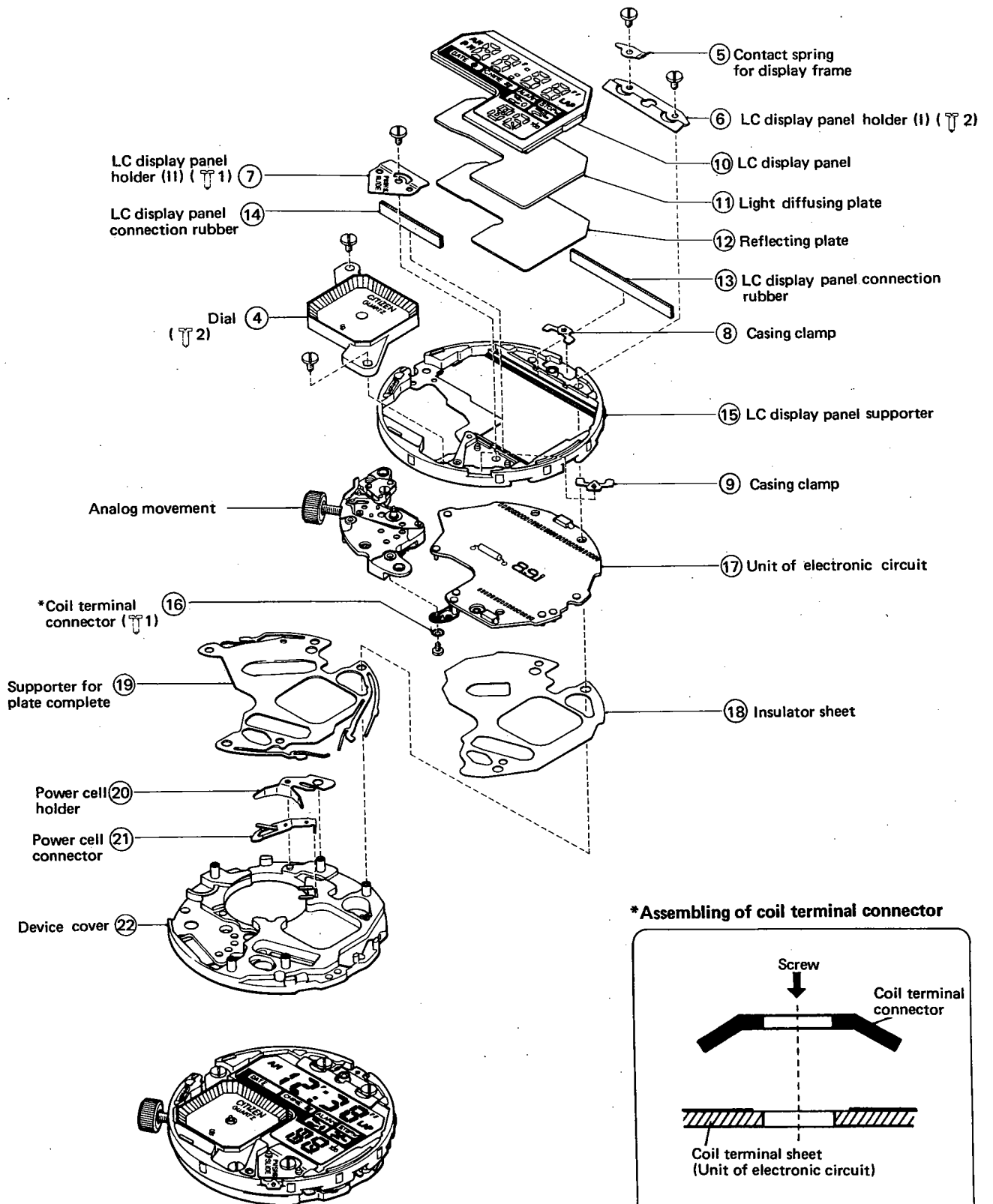

*Assembling of coil terminal connector

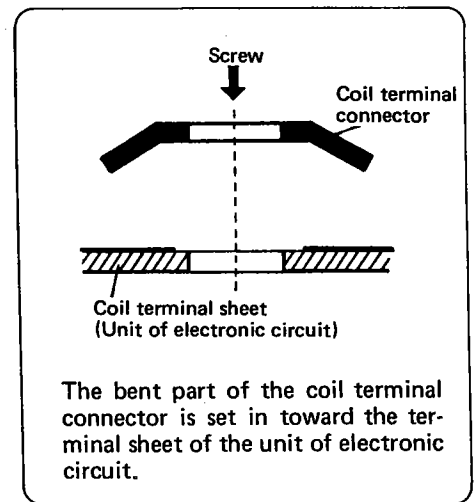

3) Analog block (Bridge side)

Lubrication marks:
 (V) Synta-V-Lube oil
 (A) Synt-A-Lube oil

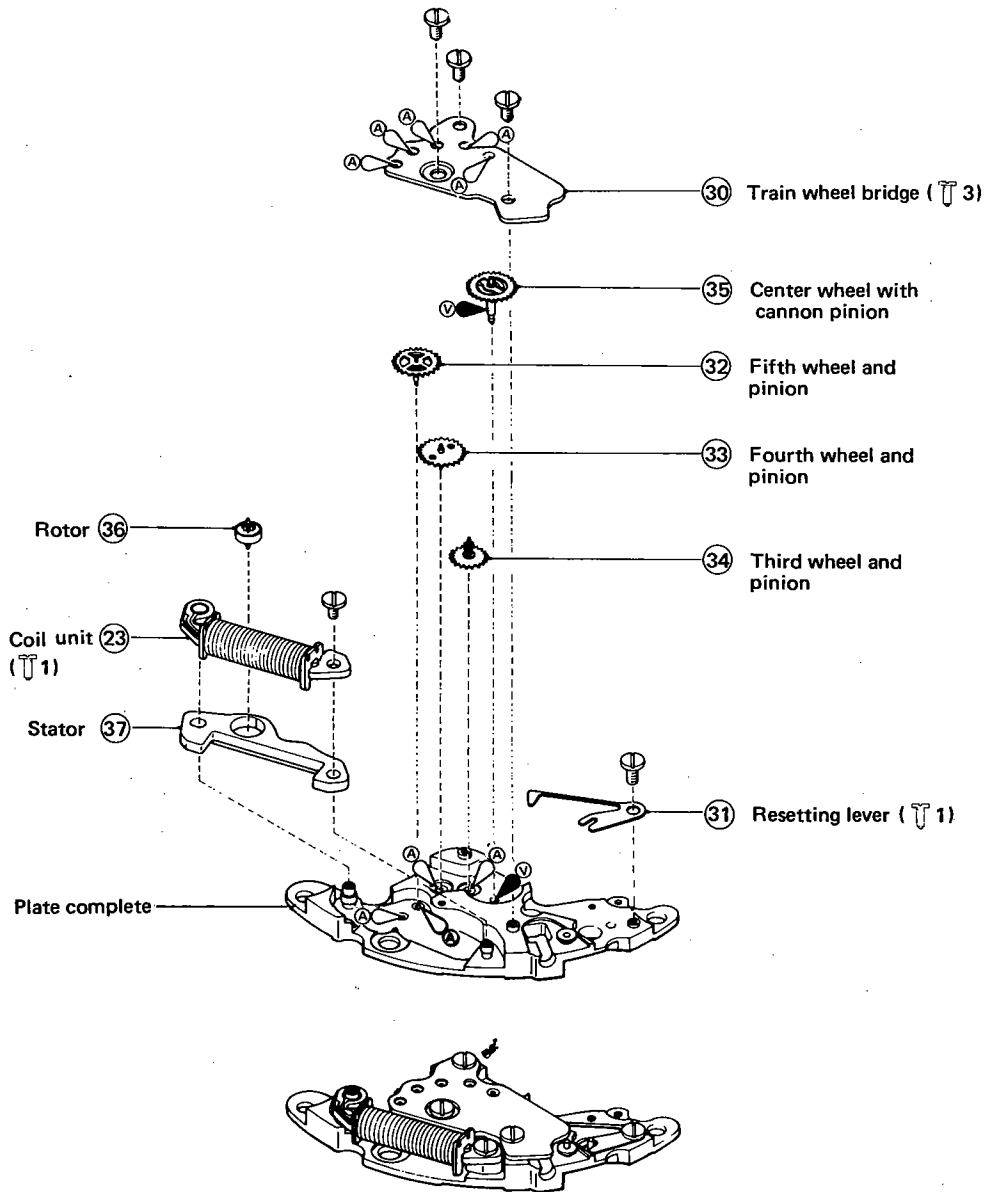

4) Analog block (Dial side)

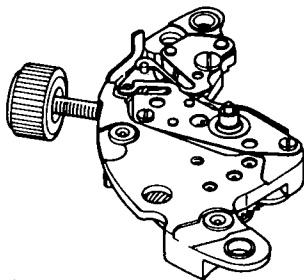
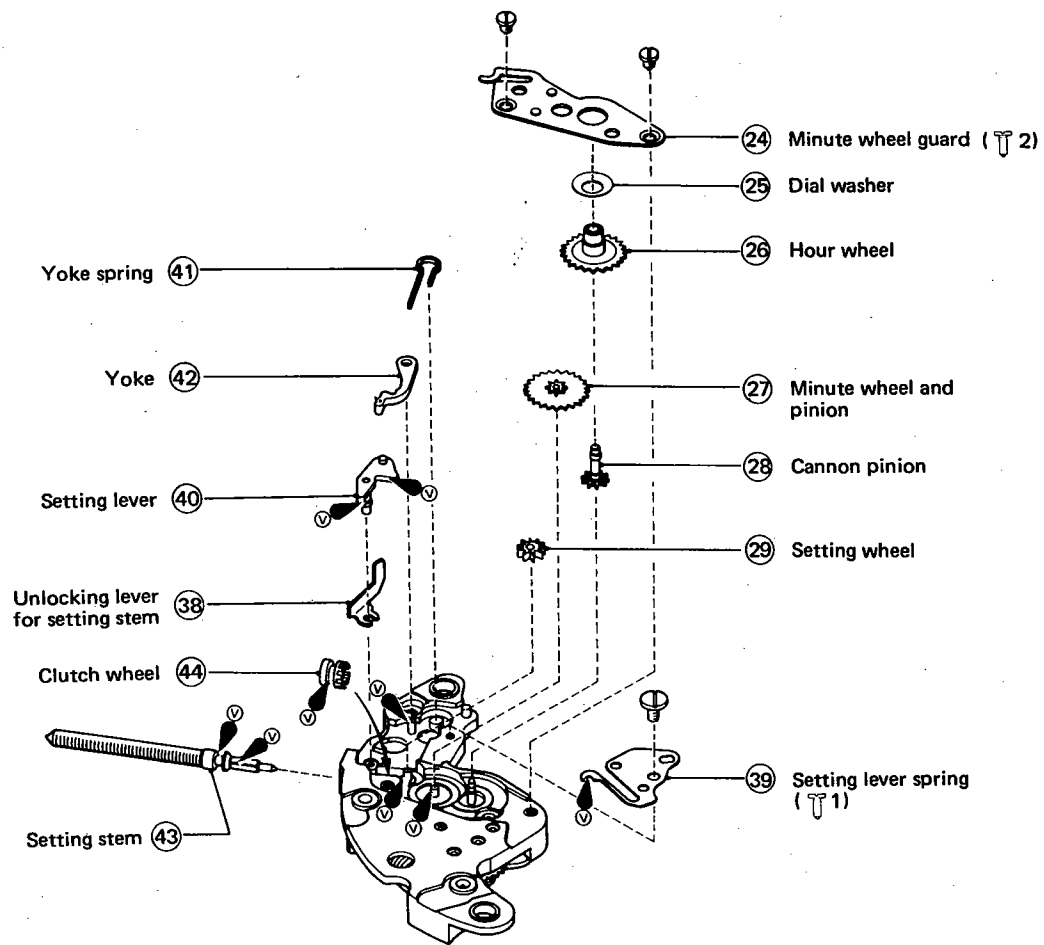

§ 8. TROUBLESHOOTING AND ADJUSTMENT

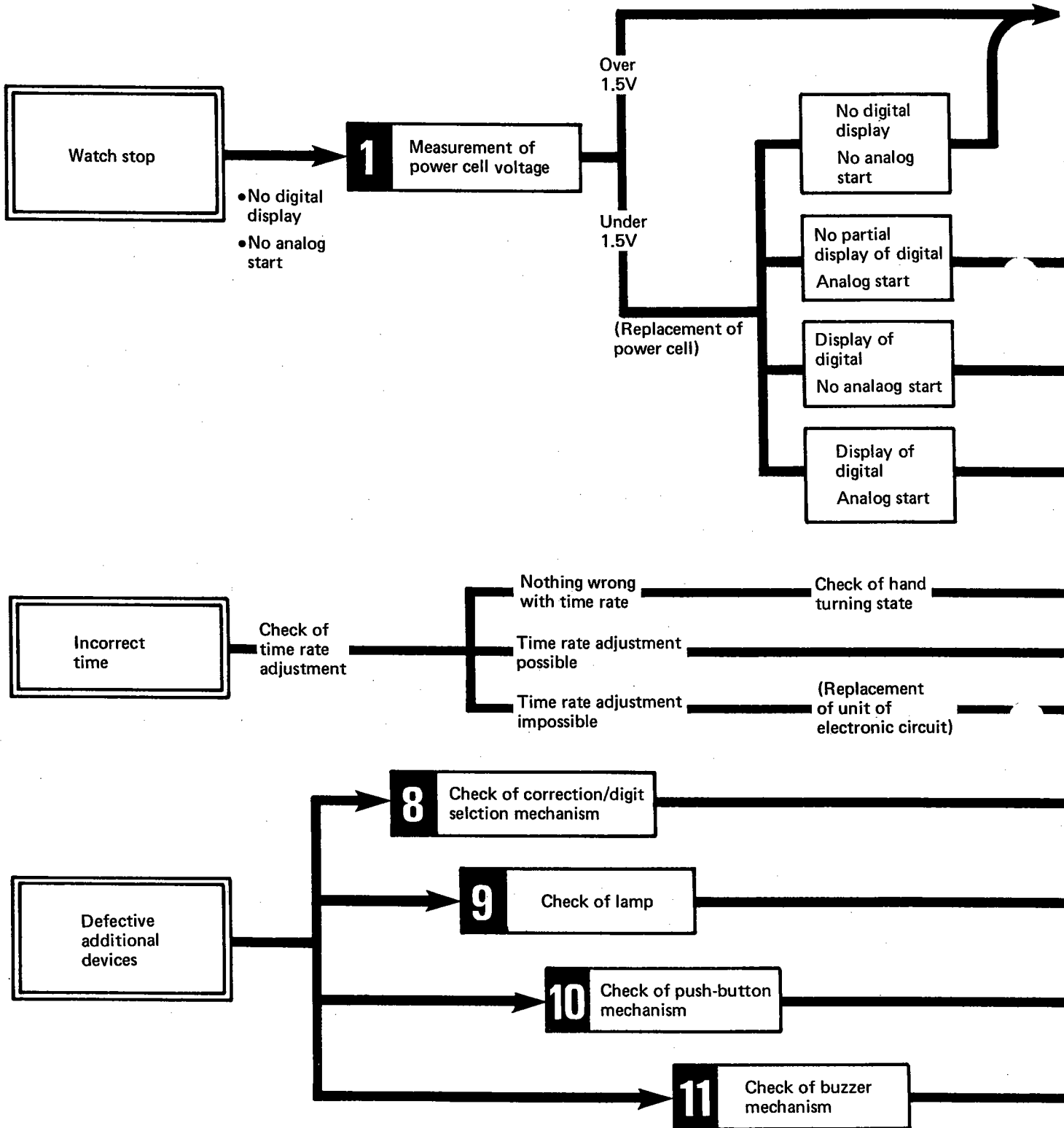

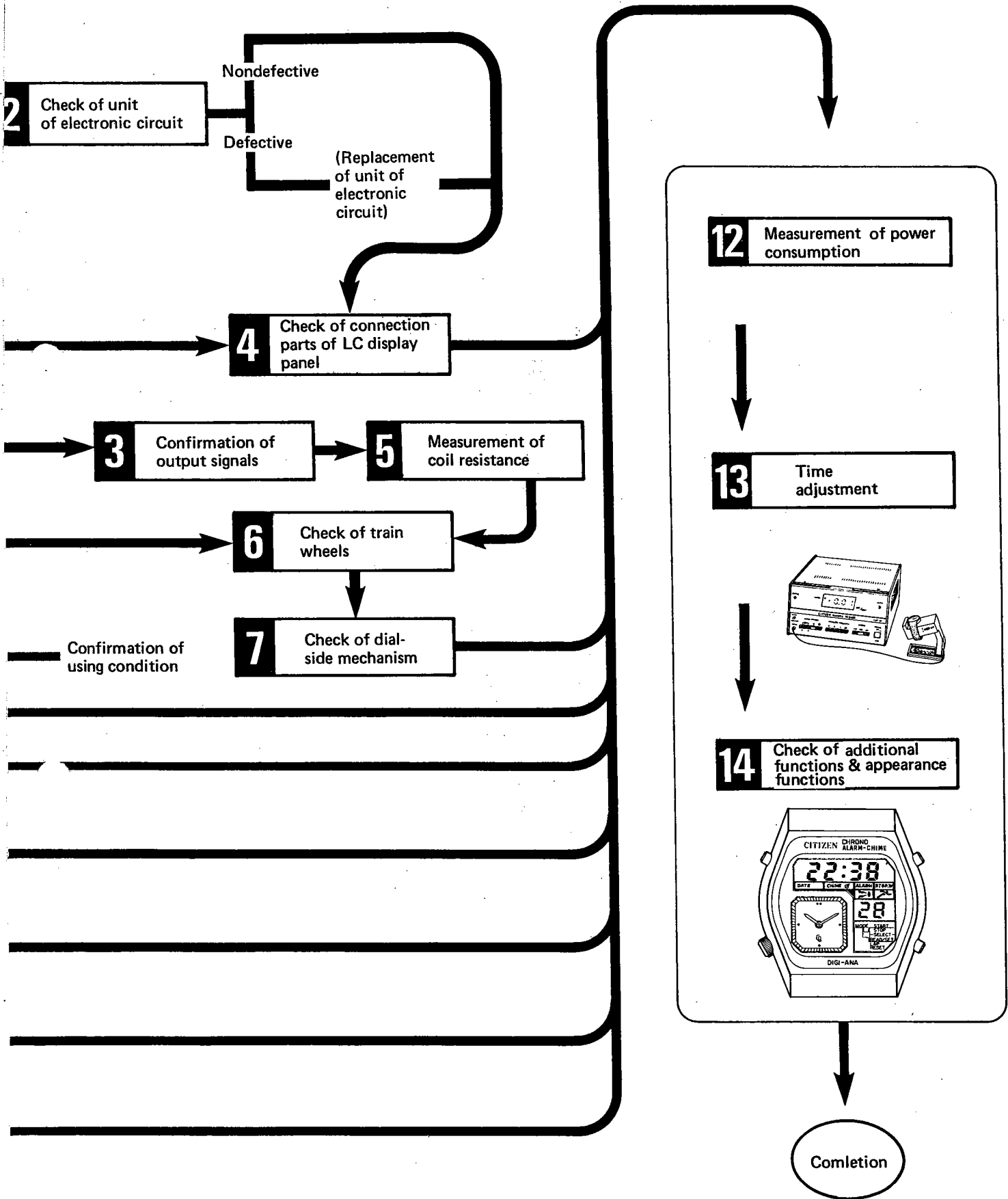

2 Check of unit of electronic circuit

Nondefective

Defective

(Replacement of unit of electronic circuit)

4 Check of connection parts of LC display panel

3 Confirmation of output signals

5 Measurement of coil resistance

6 Check of train wheels

7 Check of dial-side mechanism

Confirmation of using condition

12 Measurement of power consumption

13 Time adjustment

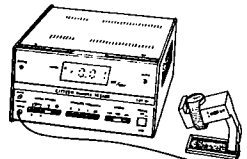

14 Check of additional functions & appearance functions

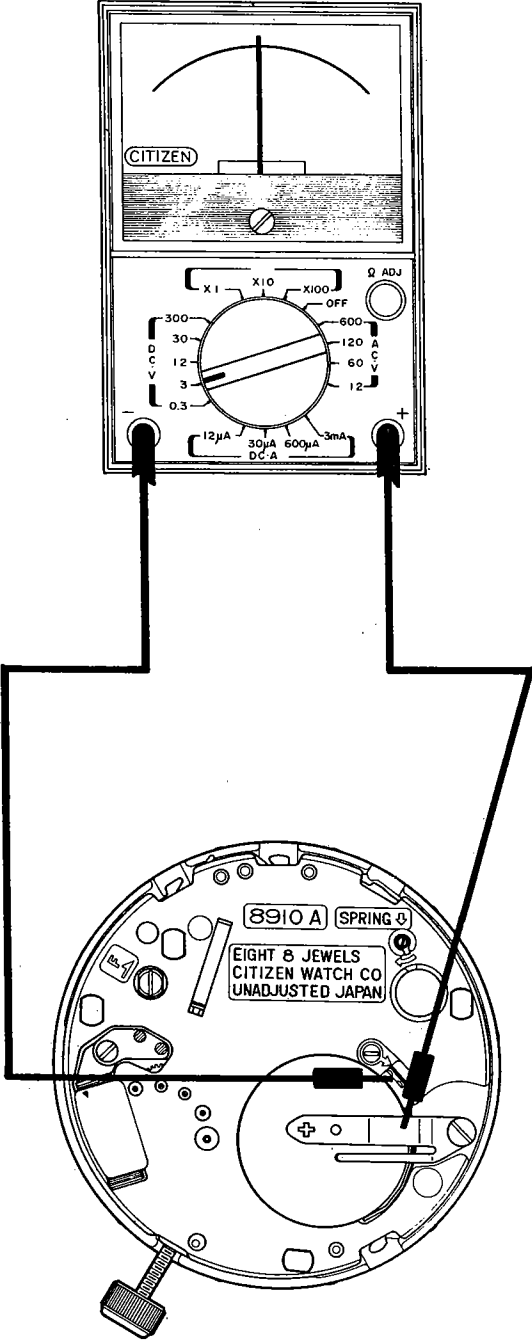

Completion

Check items	How to check	Results and treatment
<p>1 Measurement of power cell voltage</p>		<div style="border: 1px solid black; padding: 5px; margin-bottom: 10px;"> <p>Over 1.5V</p> <p>→ Nothing wrong</p> </div> <div style="border: 1px solid black; padding: 5px;"> <p>Under 1.5V</p> <p>→ Replacement of power cell</p> </div> <div style="border: 1px solid black; padding: 5px; margin-top: 20px;"> <p style="text-align: center;"><u>Note</u></p> <p>If the watch has been used more than 2 years, the power cell must be replaced although it shows more than 1.5V output.</p> </div>
<p>2 Check of unit of electronic circuit</p>	<p>For check of the unit of electronic circuit in the single-unit state, the repair tools are required to carry out replacement of the quartz crystal oscillator, the condenser and the l.ike.</p> <p>Thus, the following points are checked in terms of the "unit of electronic circuit".</p> <ol style="list-style-type: none"> 1) Whether or not each element has a contact to each other. 2) Whether or not the pattern has any stains on it. 3) And others. 	

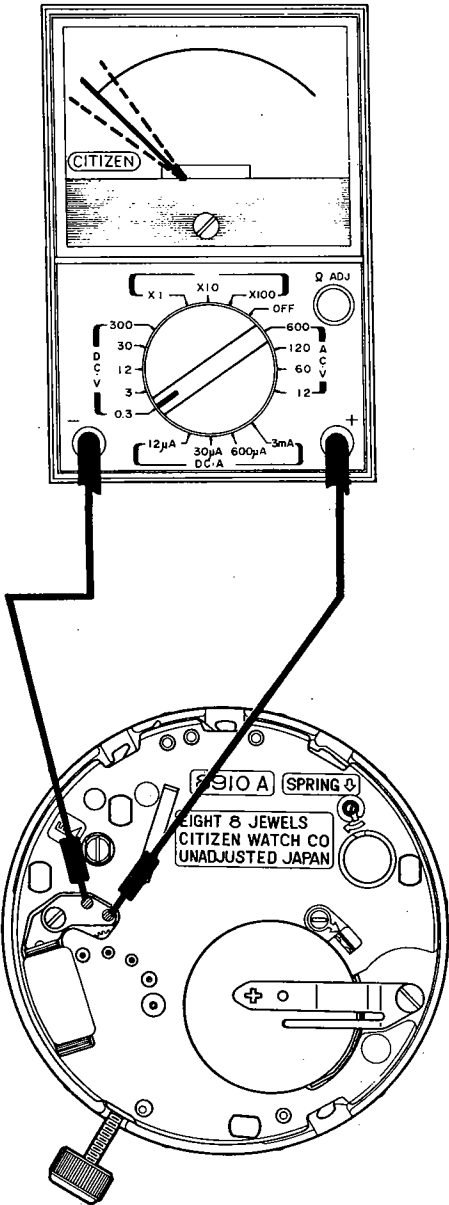
Check items	How to check	Results and treatment
<p>3 Confirmation of output signals</p>		<p>The both terminals of the tester are applied to the output terminals at the analog part of the unit of electronic circuit.</p> <p>Tester needle swinging once every 4 seconds centering on 0</p> <p>→ Nothing wrong</p> <p>Otherwise</p> <p>→ Replacement of unit of electronic circuit</p>
<p>4 Check of connection parts of LC display panel</p>	<p>The break of segments occurs when the contact is defective or unsteady between the pattern of the unit of electronic circuit and the electrode of the LC display panel.</p> <p>In this case, the upper surface of the broken segment is pressed softly with a finger to decide the following two points.</p> <ol style="list-style-type: none"> 1) Display given . . . Signals transmitted to LC display panel 2) No display No signal transmitted <ol style="list-style-type: none"> 1 Check whether or not the screws are tightened well for the LC display panel. 2 The setting state is checked for the LC display connection rubber. 3 Check whether or not some dust or stains stick to the electrode pattern between the LC display panel, the connection rubber and the unit of electronic circuit each. 	<p>Screw loosened</p> <p>→ To be tightened</p> <p>Dust or stains sticking</p> <p>→ To be removed away</p>

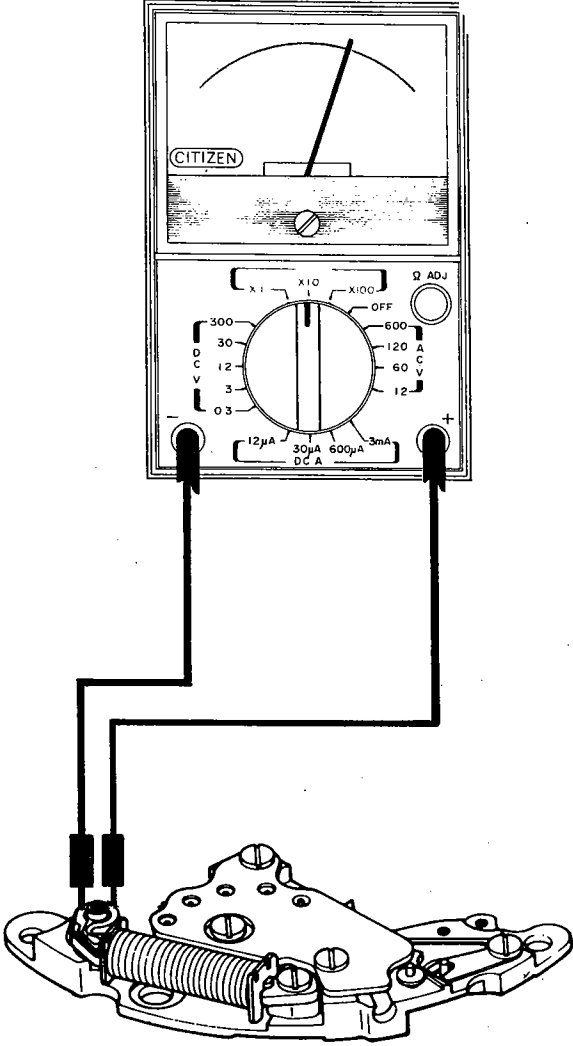
Check items	How to check	Results and treatment
<p>5 Measurement of coil resistance</p>		<p>Tester needle swinging:</p> <div style="border: 1px solid black; padding: 10px; margin: 10px 0;"> <p>Within 2.5 ~ 3.0KΩ → Nothing wrong</p> <p>Outside 2.5 ~ 3.0KΩ → Replacement of coil unit</p> </div>
<p>6 Check of train wheels</p>	<ol style="list-style-type: none"> 1) Make sure that a smooth transmission is secured for each gear. 2) The state of lubrication is checked for each gear. 3) The clearance is checked for each gear as well as the rotor. The clearance must always be confirmed whenever the analog plate complete or wheels is replaced. 	<p>No clearance secured</p> <p>→ Jewel position shifted at train wheels side to secure clearance</p>

Check items	How to check	Results and treatment
<p>7 Check of dial-side mechanism</p>	<p>1) The state of lubrication is checked. With this caliber, the train wheels of the bridge side turn along with the hand turning. This is, however, just a matter of mechanism and not a defect at all.</p> <p>The measurement of the hand-turn torque is possible with detachment of the coil unit since the holding power between the rotor and the stator is larger than the cannon pinion's torque.</p>	
<p>8 Check of correction/digit selection mechanism</p>	<div data-bbox="446 714 925 1365"> <p>Unit of electronic circuit</p> <p>Supporter for plate complete (II)</p> </div> <p>The above codes correspond to each other as follows.</p> <ul style="list-style-type: none"> Ⓐ - ⓐ : Start/stop of stopwatch, lamp Ⓑ - ⓑ : Correcting digit selection Ⓒ - ⓒ : Read/set, lap Ⓓ - ⓓ : Mode selection <p>Check whether or not each switch spring part of the supporter for plate complete (II) has some breakage, bend or wear.</p>	<p>Breakage, bend or wear detected</p> <p>→ Replacement of supporter for plate complete (II)</p>

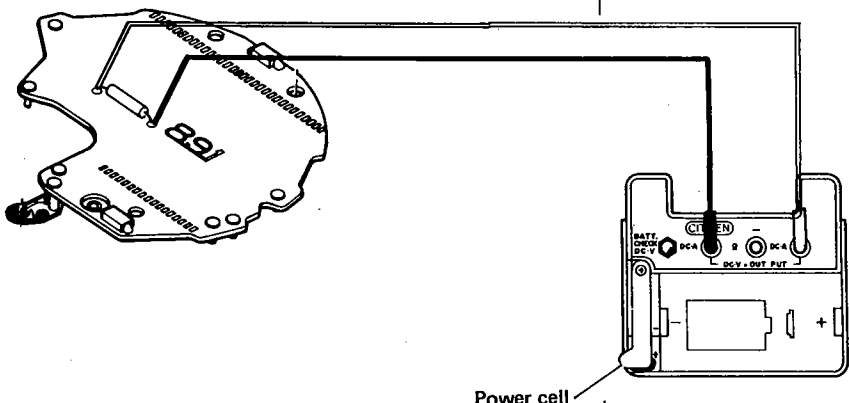
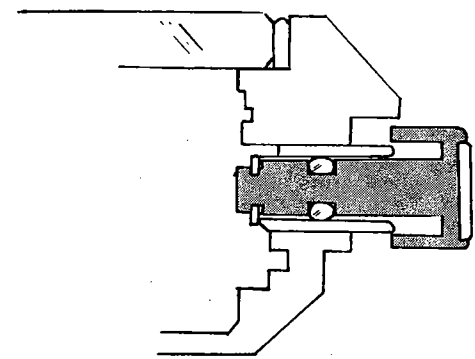
Check items	How to check	Results and treatment
<p>9 Check of lamp</p>	 <p>The quality checking is given to the lamp in the single-unit state via the adaptor of the tester. *The lamp has no polarity difference between plus (+) and minus (-).</p>	<div style="border: 1px solid black; padding: 5px;"> <p>Lamp light up → Nondefective</p> <p>No lamp lighting → Replacement of unit of electronic circuit</p> </div>
<p>10 Check of push-button mechanism</p>	<p>When the dust or other foreign matters stick to the push-buttons, the insufficient stroke occurs. This results in the defective additional devices although the supporter for plate complete (II) and the unit of electronic circuit are nondefective.</p> <ol style="list-style-type: none"> 1) Whether or not the pushing force is too strong for the push-button. 2) Whether or not some dust or stains stick to the push-buttons. 	<div style="border: 1px solid black; padding: 5px;"> <p>Pushing force too strong → Supply of Cilicone oil</p> <p>Dust or stains sticking → To be removed off</p> </div>

Check items	How to check	Results and treatment
11 Check of buzzer mechanism	<p>The following points are checked in case no buzzer rings.</p> <ol style="list-style-type: none">1) Whether or not the AM or PM is set correctly.2) Whether or not the buzzer contact spring has some bend, twist or malformation and whether the contact spring is set in completely. At the same time, an examination is given whether or not a change occurs between the complete incorporation and the light placement of the case-back or the power cell cover.3) In case the buzzer ring is unsteady, a contact may sometimes take place between the vibrating plate and the buzzer contact spring. This is proved if the buzzer ring has some change when the module is shifted a little with the crown by the amount of the clearance.4) Whether or not the terminal part of the alarm boosting coil has any disconnection.	<p>Contact spring bent, twisted or deformed</p> <p>—————> Replacement of spring</p> <p>Coil terminal disconnected</p> <p>—————> Replacement of unit of electronic circuit</p>

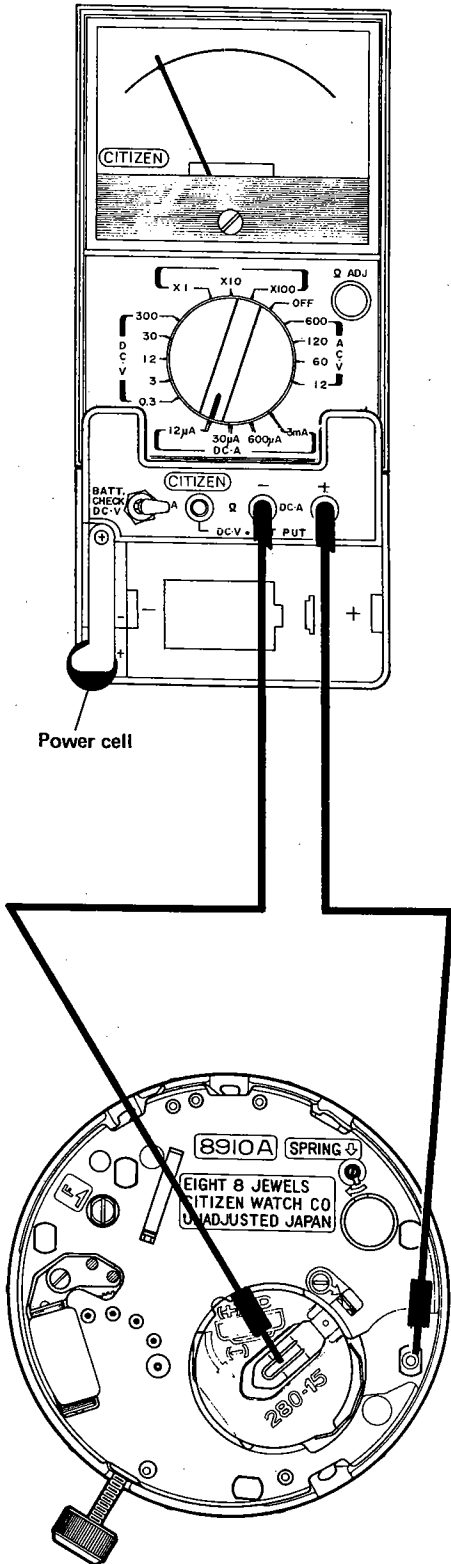
Check items	How to check	Results and treatment
<p>12 Measurement of power consumption</p>	 <p>The diagram illustrates the setup for measuring power consumption. A CITIZEN multimeter is shown with its dial set to the 12µA range under the DC-A (Direct Current Amperes) section. The multimeter is connected to a power cell and the terminals of a watch movement. The watch movement is labeled with '8910A SPRING', 'EIGHT 8 JEWELS', 'CITIZEN WATCH CO.', 'UNADJUSTED JAPAN', and '28015'.</p>	<p>Power consumption read through tester and in state of module complete:</p> <ul style="list-style-type: none"> Under 3.5µA <ul style="list-style-type: none"> → Nothing wrong Over 3.5µA <ul style="list-style-type: none"> → Measurement of power consumption with single unit of electronic circuit <p>Power consumption read with single unit of electronic circuit:</p> <ul style="list-style-type: none"> Under 2.0µA <ul style="list-style-type: none"> → Nondefective unit of electronic circuit → Replacement of LC display panel or LC display panel connection rubber Over 2.0µA <ul style="list-style-type: none"> → Replacement of unit of electronic circuit

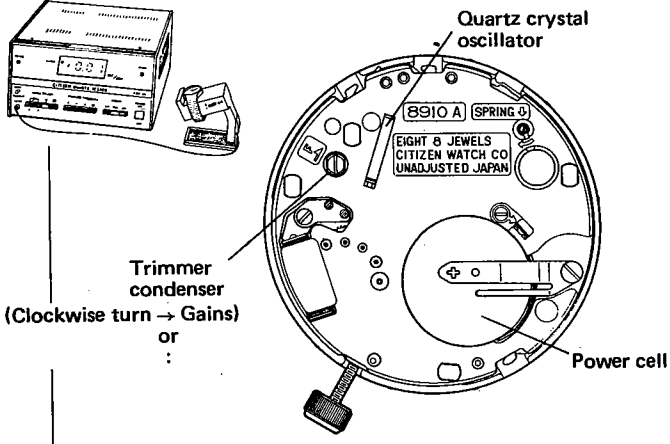
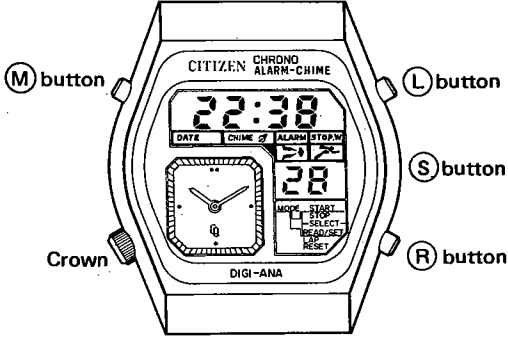
Check items	How to check	Results and treatment
<p>13 Time adjustment</p>	<p>The time rate is measured through CQT-101, and then the time is adjusted by turning the trimmer condenser.</p>  <p>Quartz crystal oscillator</p> <p>TRIMMER CONDENSER</p> <p>(Clockwise turn → Gains) or :</p> <p>Power cell</p> <p>EIGHT JEWELS CITIZEN WATCH CO UNADJUSTED JAPAN</p>	<p>Adjustment possible</p> <p>→ Check of appearance functions</p> <p>Adjustment impossible</p> <p>→ Replacement of unit of electronic circuit</p> <div style="border: 1px solid black; padding: 5px; margin-top: 10px;"> <p style="text-align: center;">Note</p> <p>The digital and the analog signals emerge once per second and once every 4 seconds respectively.</p> </div>
<p>14 Check of appearance functions</p>	 <p>The following points are checked in the state of a completed watch.</p> <ul style="list-style-type: none"> • Display of time <ol style="list-style-type: none"> 1) Whether or not the illumination lamp glows with push of (L) button. 2) Whether or not the switching is possible between AM and PM as well as between the 12-hour and 24-hour displays along with ringing of the buzzer with simultaneous push of (L) and (R) buttons. • Switching function <ol style="list-style-type: none"> 1) Whether or not the switching is possible to the calendar with push of (R) button. 2) Whether or not the "second" starts flashing (for 1.5 ~ 2.0 seconds) with push of (S) button. 3) Whether or not the display switching is carried out in that order of the chime → alarm → stopwatch with push of (M) button. • Others <ol style="list-style-type: none"> 1) Whether or not some dust or stains attach onto the dial or the display frame. 2) Whether or not the all-reset function operates correctly to give the following displays with simultaneous push of (L), (S) and (R) buttons. 	<pre> ~ 12:00 00 12. 1 SU 70 Chime :00 0F Alarm ~ 12:00 0F Stopwatch 00'00"00 </pre>

CITIZEN WATCH CO., LTD.

Tokyo, Japan